



User Manual

English

APC Smart-UPS®

**500 VA
100 VAC**

**750 VA
100/120/230 VAC**

**Tower
Uninterruptible Power Supply**

Introduction

The APC Uninterruptible Power Supply (UPS) is designed to prevent blackouts, brownouts, sags, and surges from reaching your equipment. The uninterruptible power supply (UPS) filters small utility line fluctuations and isolates your equipment from large disturbances by internally disconnecting from the utility line. The UPS provides continuous power from its internal battery until the utility line returns to safe levels or the battery is fully discharged.

1: INSTALLATION

The User Manual and Safety Guide are accessible on the supplied User Manuals CD and on the APC web site, www.apc.com.

Unpack

Attention: Read the safety instruction sheet before installation.

Inspect the UPS upon receipt. Notify the carrier and dealer if there is damage.

The packaging is recyclable; save it for reuse or dispose of it properly.

Check the package contents:

Attention: The UPS comes with battery disconnected.

- ❑ UPS
- ❑ UPS literature kit containing:
 - ❑ Product documentation, safety and warranty information
 - ❑ Smart-UPS[®] User Manuals CD
 - ❑ 120V and 230V models: PowerChute[®] CD
 - ❑ 120V and 230V models: Serial and USB communication cables
 - ❑ 230V model: Two jumper cables

Position the UPS

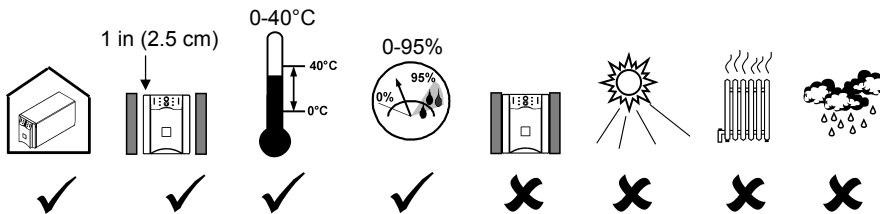

Connect the Battery

The battery connector is located on the rear panel.

For battery connection, push the tethered jumper plug into the corresponding port.

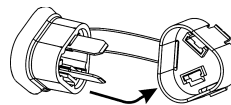

Connect Equipment and Power to the UPS

1. Connect equipment to the UPS.

Note: A laser printer draws significantly more power than other types of equipment and may overload the UPS.

2. Add accessories to the Smart-Slot (optional).
3. Connect ground leads to the TVSS screw (optional). To make the connection, loosen the screw and connect the surge suppression device ground lead. Tighten the screw to secure the lead.
4. Plug the UPS into a two-pole, three-wire, grounded receptacle only. Avoid using extension cords.

100V/120V models: The power cord is attached to the UPS. The input plug is a NEMA 5-15P.

230V model: The power cord is supplied in the UPS literature kit.

5. *120V model:* Check the *site wiring fault* LED  located on the rear panel. It will be illuminated if the UPS is plugged into an improperly wired utility power outlet (see *Troubleshooting*).
6. Turn on all connected equipment. To use the UPS as a master *on/off* switch, be sure all connected equipment is on.

7. Press the  button on the front panel to power the UPS.

Note: The battery charges to 90% capacity during the first four hours of normal operation. Do not expect full battery run capability during this initial charge period.

8. For optimal computer system security, install PowerChute Smart-UPS monitoring software.

Rear Panels

100V/120V

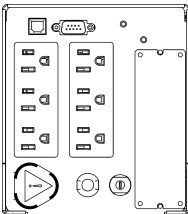

230V

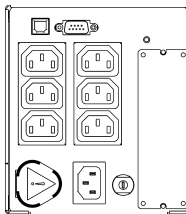

Basic Connectors

Serial Port



USB Port



TVSS Screw



Use only interface kits approved by APC.

Use only the supplied cable to connect to the Serial Port. A standard serial interface cable is incompatible with the UPS. **Serial and USB Ports cannot be used simultaneously.**







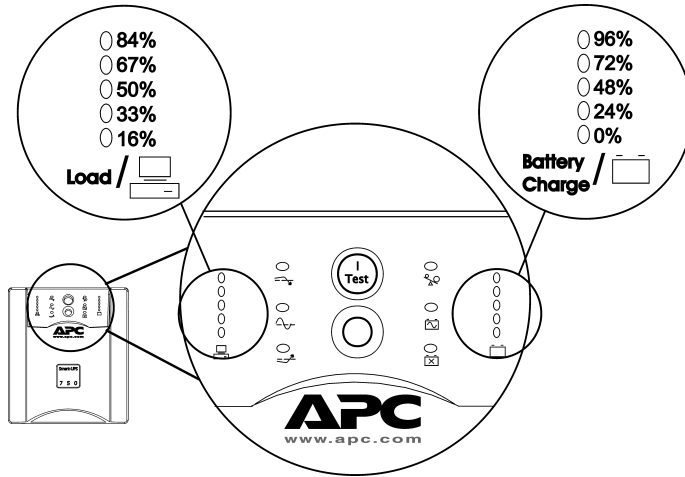

The UPS features a transient voltage surge-suppression (TVSS) screw for connecting the ground lead on surge suppression devices such as telephone and network line protectors.











When connecting grounding cable, disconnect the UPS from utility power.

2: OPERATION

Front Display Panel



INDICATOR	DESCRIPTION
	The UPS is supplying utility power to the connected equipment.
	The UPS is compensating for a high utility voltage.
	The UPS is compensating for a low utility voltage.
	The UPS is supplying battery power to the connected equipment.
	The connected loads are drawing more than the UPS power rating.
	The battery is disconnected or must be replaced.
FEATURE	FUNCTION
	Press this button to turn on the UPS. (Read on for additional capabilities.)
	Press this button to turn off the UPS.

FEATURE	FUNCTION																					
Self-Test	<p>Automatic: The UPS performs a self-test automatically when turned on, and every two weeks thereafter (by default). During the self-test, the UPS briefly operates the connected equipment on battery.</p> <p>Manual: Press and hold the  button for a few seconds to initiate the self-test.</p>																					
Cold Start	<p><i>120V and 230V models only:</i> Supply battery power to the UPS and connected equipment in the absence of utility voltage (see <i>Troubleshooting</i>). Press the  button for one second and release. The UPS will beep briefly and go quiet. Press and hold the button again, but for approximately three seconds. The unit will emit a sustained beep. Release the button during this beep.</p>																					
Diagnostic Utility Voltage <table border="0"> <tr> <td>100V</td> <td>120V</td> <td>230V</td> </tr> <tr> <td>0 119</td> <td>0 133</td> <td>0 266</td> </tr> <tr> <td>0 109</td> <td>0 124</td> <td>0 248</td> </tr> <tr> <td>0 100</td> <td>0 114</td> <td>0 229</td> </tr> <tr> <td>0 91</td> <td>0 105</td> <td>0 210</td> </tr> <tr> <td>0 81</td> <td>0 96</td> <td>0 191</td> </tr> <tr> <td></td> <td>Battery Charge</td> <td></td> </tr> </table>	100V	120V	230V	0 119	0 133	0 266	0 109	0 124	0 248	0 100	0 114	0 229	0 91	0 105	0 210	0 81	0 96	0 191		Battery Charge		<p>The UPS has a diagnostic feature that displays the utility voltage.</p> <p>The UPS starts a self-test as part of this procedure. The self-test does not affect the voltage display.</p> <p>Press and hold the  button to view the utility voltage bar graph display. After a few seconds, this five-LED <i>battery charge</i>  display on the right of the front panel will show the utility input voltage.</p> <p>Refer to the figure at left for the voltage reading (values are not listed on the UPS).</p> <p>The display indicates the voltage is between the displayed value on the list and the next higher value (see <i>Troubleshooting</i>).</p>
100V	120V	230V																				
0 119	0 133	0 266																				
0 109	0 124	0 248																				
0 100	0 114	0 229																				
0 91	0 105	0 210																				
0 81	0 96	0 191																				
	Battery Charge																					

Battery Operation

The UPS switches to battery operation automatically if the utility power fails. While running on battery, an alarm beeps four times every 30 seconds.

Press the  button to silence this alarm. If the utility power does not return, the UPS continues to supply power to the connected equipment until the battery is fully discharged.

If PowerChute is not being used, files must be manually saved and the computer must be turned off before the UPS fully discharges the battery.

Refer to www.apc.com for on battery runtimes.

3: USER CONFIGURABLE ITEMS

NOTE: SETTINGS ARE ADJUSTED THROUGH POWERCHUTE SOFTWARE OR OPTIONAL SMART SLOT ACCESSORY CARDS.			
FUNCTION	FACTORY DEFAULT	USER SELECTABLE CHOICES	DESCRIPTION
Automatic Self-Test	Every 14 days (336 hours)	Every 7 days (168 hours), On Startup Only, No Self-Test	Set the interval at which the UPS will execute a self-test.
UPS ID	UPS_IDEN	Up to eight characters (alphanumeric)	Uniquely identify the UPS, (i.e. server name or location) for network management purposes.
Date of Last Battery Replacement	Manufacture Date	mm/dd/yy	Reset this date when you replace the battery module.
Minimum Capacity Before Return from Shutdown	0 percent	0, 15, 30, 45, 50, 60, 75, 90 percent	Specify the percentage to which batteries will be charged following a low-battery shutdown before powering connected equipment.
Voltage Sensitivity The UPS detects and reacts to line voltage distortions by transferring to battery operation to protect connected equipment.	High	High sensitivity, Medium sensitivity, Low sensitivity	Note: In situations of poor power quality, the UPS may frequently transfer to battery operation. If the connected equipment can operate normally under such conditions, reduce the sensitivity setting to conserve battery capacity and service life.
Alarm Delay Control	Enable	Enable, Mute, Disable	Mute ongoing alarms or disable all alarms permanently.
Shutdown Delay	90 seconds	0, 90, 180, 270, 360, 450, 540, 630 seconds	Set the interval between the time when the UPS receives a shutdown command and the actual shutdown.
Low Battery Warning	2 minutes PowerChute software provides automatic, unattended shutdown when approximately 2 minutes of battery operated runtime remains.	2, 5, 8, 11, 14, 17, 20, 23 minutes (Times are approximate.)	The UPS will beep when 2 minutes of battery runtime remains. Change the low battery warning interval setting to the time that the operating system or system software requires to safely shut down.
Synchronized Turn-on Delay	0 seconds	0, 60, 120, 180, 240, 300, 360, 420 seconds	Specify the time the UPS will wait after the return of utility power before turn-on (to avoid branch circuit overload).

**NOTE: SETTINGS ARE ADJUSTED THROUGH POWERCHUTE SOFTWARE
OR OPTIONAL SMART SLOT ACCESSORY CARDS.**

FUNCTION	FACTORY DEFAULT	USER SELECTABLE CHOICES	DESCRIPTION
High Transfer Point	<i>100V model:</i> 108 Vac <i>120V model:</i> 127 Vac <i>230V model:</i> 253 Vac	<i>100V model:</i> 108, 110, 112, 114 Vac <i>120V model:</i> 127, 130, 133, 136 Vac <i>230V model:</i> 253, 257, 261, 265 Vac	Set the high transfer point higher to avoid unnecessary battery usage when the utility voltage is usually high and the connected equipment is specified to operate with input voltages this high.
Low Transfer Point	<i>100V model:</i> 92 Vac <i>120V model:</i> 106 Vac <i>230V model:</i> 208 Vac	<i>100V model:</i> 86, 88, 90, 92 Vac <i>120V model:</i> 97, 100, 103, 106 Vac <i>230V model:</i> 196, 200, 204, 208 Vac	Set the low transfer point lower when the utility voltage is usually low and the connected equipment is specified to operate with input voltages this low.
Output Voltage (<i>230V model only</i>)	230 Vac	220, 230, 240 Vac	Select the output voltage.

4: STORAGE, MAINTENANCE, AND SHIPPING

Storage

Store the UPS covered in a cool, dry location, with the battery fully charged.

At -15 to +30 °C (+5 to +86 °F), charge the UPS battery every six months.

At +30 to +45 °C (+86 to +113 °F), charge the UPS battery every three months.

Battery Module Maintenance

The UPS battery life differs based on usage and environment. Consider replacing the battery every three years.

This UPS has an easy to replace, hot-swappable battery. Replacement is a safe procedure, isolated from electrical hazards. You may leave the UPS and connected equipment on during the replacement procedure. See your dealer or contact APC (see *Contact Information*) for information on replacement batteries.

Note: Upon battery disconnection, equipment is not protected from power outages.

Removing the Front Bezel and Battery Module

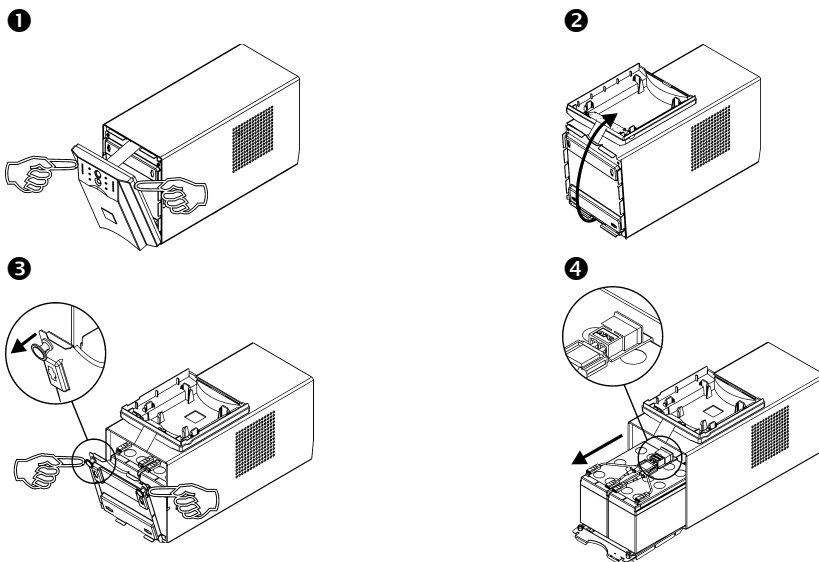

Replacing the Battery Module

Reverse the instructions for *Removing the Front Bezel and Battery Module*. Note: To close the battery door, ensure the plungers are in the extended position, push the door shut, and push the plungers into the locked position.



Be sure to deliver the spent battery to a recycling facility or ship it to APC in the replacement battery packing material.

Shipping

1. Shut down and disconnect any equipment attached to the UPS.
2. Shut down the UPS, and disconnect the UPS from the utility power outlet.
3. Unplug the battery connector, located on the rear panel.

For further shipping instructions and to obtain appropriate packing materials, contact APC (see *Contact Information*).

5: TROUBLESHOOTING

Use the chart below to solve minor UPS installation and operation problems. Refer to www.apc.com with complex UPS problems.

PROBLEM AND/OR POSSIBLE CAUSE	SOLUTION
<i>UPS WILL NOT TURN ON</i>	
UPS not connected to utility power supply.	Check that the power cord from the UPS to the utility power supply is securely connected at both ends.
Battery not connected properly.	Check that battery connector on the rear panel is fully snapped into position.
Very low or no utility voltage.	Check the utility power supply to the UPS by plugging in a table lamp. If the light is very dim, have the utility voltage checked.
<i>UPS WILL NOT TURN OFF</i>	
Internal UPS fault.	Do not attempt to use the UPS. Unplug the UPS, unplug the battery connector on the rear panel, and have it serviced immediately.
<i>UPS BEEPS OCCASIONALLY</i>	
Normal operating UPS beeps when running on battery.	None. The UPS is protecting the connected equipment from occasional utility power irregularities.
<i>UPS IS NOT PROVIDING EXPECTED BACKUP TIME</i>	
The UPS battery is weak due to a recent outage or is near the end of the service life.	Charge the battery. Batteries require recharging after extended outages, and wear faster when frequently put into service or when operated at elevated temperatures. If the battery is near the end of the service life, consider replacing even if the <i>replace battery</i> LED is not yet illuminated.
<i>LEFT HALF, RIGHT HALF, OR CENTER SECTION OF FRONT PANEL LEDES ARE FLASHING</i>	
Internal UPS fault. The UPS has shut down.	Do not attempt to use the UPS. Turn off the UPS, unplug the battery connector on the rear panel, and have it serviced immediately.
<i>FRONT PANEL LEDES FLASH SEQUENTIALLY</i>	
The UPS has been shut down remotely through software or an optional accessory card.	None. The UPS will restart automatically when utility power returns.
<i>ALL LEDES ARE OFF AND THE UPS IS PLUGGED INTO A WALL OUTLET</i>	
The UPS is shut down or the battery is discharged from an extended outage.	None. The UPS will return to normal operation when the power is restored and the battery has a sufficient charge.

PROBLEM AND/OR POSSIBLE CAUSE	SOLUTION
<i>THE OVERLOAD LED IS ILLUMINATED AND THE UPS EMITS A SUSTAINED ALARM TONE</i>	
The UPS is overloaded. The connected equipment is drawing more VA than the UPS can sustain.	<p>The connected equipment exceeds the specified “maximum load.”</p> <p>The alarm remains on until the overload is removed. Disconnect nonessential equipment from the UPS to eliminate the overload.</p> <p>The UPS continues to supply power as long as it is online and the circuit breaker does not trip; the UPS will not provide power from batteries in the event of a utility voltage interruption.</p> <p>If a continuous overload occurs while the UPS is on battery, the unit turns off output in order to protect the UPS from possible damage.</p>
<i>THE REPLACE BATTERY/BATTERY DISCONNECTED LED IS ILLUMINATED</i>	
This LED flashes and a short beep is emitted every two seconds to indicate the battery is disconnected.	Check that the battery connector on the rear panel is fully engaged.
Weak battery.	Allow the battery to recharge for 24 hours. Then, perform a self-test. If the problem persists after recharging, replace the battery.
Failure of a battery self-test.	The UPS emits short beeps for one minute and the <i>replace battery</i> LED illuminates. The UPS repeats the alarm every five hours. Perform the self-test procedure after the battery has charged for 24 hours to confirm the <i>replace battery</i> condition. The alarm stops and the LED clears if the battery passes the self-test.
<i>THE SITE WIRING FAULT LED ON THE REAR PANEL IS ILLUMINATED (120V MODEL ONLY)</i>	
The UPS is plugged into an improperly wired utility power outlet.	<p>Wiring faults detected include missing ground, hot-neutral polarity reversal, and overloaded neutral circuit.</p> <p>Contact a qualified electrician to correct the building wiring.</p>
<i>THE INPUT CIRCUIT BREAKER HAS TRIPPED</i>	
The UPS is overloaded. The plunger on the circuit breaker has popped out.	Reduce the load on the UPS by unplugging equipment. Press in the plunger on the circuit breaker.
<i>THE AVR BOOST OR AVR TRIM LEADS ARE ILLUMINATED</i>	
The system is experiencing excessive periods of low or high voltage.	Seek qualified service personnel to check your facility for electrical problems. If the problem continues, contact the utility company for further assistance.
<i>UPS OPERATES ON BATTERY ALTHOUGH UTILITY VOLTAGE EXISTS</i>	
The UPS input circuit breaker has tripped.	To reduce the load on the UPS, unplug equipment and press in the plunger on the circuit breaker.
The line voltage is very high, low or distorted.	Move the UPS to a different outlet on a different circuit, as inexpensive fuel powered generators may distort the voltage. Test the input voltage with the utility voltage display (see <i>Operation</i>). If acceptable to the connected equipment, reduce the UPS sensitivity (see <i>User Configurable Items</i>).

PROBLEM AND/OR POSSIBLE CAUSE	SOLUTION
BATTERY CHARGE AND LOAD LED BARGRAPHS FLASH SIMULTANEOUSLY	
The UPS has shutdown. The internal temperature of the UPS has exceeded the allowable threshold for safe operation.	<p>Check that the room temperature is within the specified limits for operation.</p> <p>Check that the UPS is properly installed, allowing for adequate ventilation (see <i>Position the UPS</i>).</p> <p>Allow the UPS to cool down. Restart the UPS. If the problem continues, contact APC (see <i>Contact Information</i>).</p>
DIAGNOSTIC UTILITY VOLTAGE	
All five LEDs are illuminated.	The line voltage is extremely high and should be checked by an electrician.
There is no LED illumination.	If the UPS is plugged into a properly functioning utility power outlet, the line voltage is extremely low.
ONLINE LED	
There is no illumination.	The UPS is running on battery, or it must be turned on.
The LED is blinking.	The UPS is running an internal self-test.

Service

If the UPS requires service do not return it to the dealer. Follow these steps:

1. Review the problems discussed in *Troubleshooting* to eliminate common problems.
2. If the problem persists, contact APC Customer Service through the APC web site, www.apc.com/support.
 - Note the model number of the UPS, the serial number, and the date purchased. If you call APC Customer Service, a technician will ask you to describe the problem and attempt to solve it over the phone. If this is not possible, the technician will issue a Returned Material Authorization Number (RMA#).
 - If the UPS is under warranty, repairs are free.
3. Pack the UPS in its original packaging. If this is not available, refer to www.apc.com/support for information about obtaining a new set.
 - Pack the UPS properly to avoid damage in transit. Never use Styrofoam beads for packaging. Damage sustained in transit is not covered under warranty.
 - **Always DISCONNECT THE BATTERY before shipping in compliance with U.S. Department of Transportation (DOT) regulations.** The battery module(s) may remain in the UPS; it does not have to be removed.
4. Mark the RMA# on the outside of the package.
5. Return the UPS by insured, prepaid carrier to the address given to you by Customer Service.

Contact Information

U.S. Customers - Refer to www.apc.com/support.

International Customers - Refer to www.apc.com, select the appropriate country from the country selection field, and select the *Support* tab at the top of the web page.

6: REGULATORY AND WARRANTY INFORMATION

100V/120V models



警告使用者：
這是甲類的資訊產品，在居住的環境中使用時，可能會造成射頻干擾，在這種情況下，使用者會被要求採取某些適當的對策。

This equipment has been tested and found to comply with the limits for a Class A digital device, pursuant to part 15 of the FCC Rules. These limits are designed to provide reasonable protection against harmful interference when the equipment is operated in a commercial environment. This equipment generates, uses, and can radiate radio frequency energy and, if not installed and used in accordance with the instruction manual, may cause harmful interference to radio communications. Operation of this equipment in a residential area is likely to cause harmful interference in which case the user will be required to correct the interference at his/her own expense.

Shielded signal cables must be used with this product to ensure compliance with the Class A FCC limits.

230V models



This is a Class A product. In a domestic environment this product may cause radio interference, in which case the user may be required to take corrective actions.

2003

Date of product declaration

EC Declaration of Conformity

We, the undersigned, declare under our sole responsibility that the equipment specified below conforms to the following standards and directives:

Standards to Which Conformity Declared: IEC/EN 62040-1-1, -2, IEC 60950-1, and EN 60950-1

Application of Council Directives: 73/23/EEC, 89/336/EEC, 91/157/EEC, 92/31/EEC

Type of Equipment: Uninterruptible Power Supply

Model Numbers: SUA7501

Manufacturer's Name and Address:

American Power Conversion 132 Fairgrounds Road West Kingston, Rhode Island, 02892, USA -or-	American Power Conversion Lot 10, Block 16, Phase 4 PEZA, Rosario, Cavite Philippines
American Power Conversion (A. P. C.) b. v. Ballybritt Business Park Galway, Ireland -or-	-or- American Power Conversion Lot 3, Block 14, Phase 3 PEZA, Rosario, Cavite Philippines
American Power Conversion 2nd Street PEZA Cavite Economic Zone Rosario, Cavite Philippines -or-	-or- APC (Suzhou) UPS Co., Ltd 339 Suhong Zhong Lu Suzhou Industrial Park Suzhou Jiangsu 215021 P R China

Importer's Name and Address: American Power Conversion (A. P. C.) b. v.
Ballybritt Business Park
Galway, Ireland

Place: N. Billerica, MA U.S.A. Richard J. Everett, Sr. Regulatory Compliance Engineer
Richard J. Everett 5 Jan 03

Place: Galway, Ireland Ray S. Ballard, Managing Director, Europe
Ray S. Ballard 5 Jun 03

Limited Warranty

American Power Conversion (APC) warrants its products to be free from defects in materials and workmanship for a period of two years from the date of purchase. Its obligation under this warranty is limited to repairing or replacing, at its own sole option, any such defective products. To obtain service under warranty you must obtain a Returned Material Authorization (RMA) number from customer support. Products must be returned with transportation charges prepaid and must be accompanied by a brief description of the problem encountered and proof of date and place of purchase. This warranty does not apply to equipment that has been damaged by accident, negligence, or misapplication or has been altered or modified in any way. This warranty applies only to the original purchaser who must have properly registered the product within 10 days of purchase.

EXCEPT AS PROVIDED HEREIN, AMERICAN POWER CONVERSION MAKES NO WARRANTIES, EXPRESSED OR IMPLIED, INCLUDING WARRANTIES OF MERCHANTABILITY AND FITNESS FOR A PARTICULAR PURPOSE. Some states do not permit limitation or exclusion of implied warranties; therefore, the aforesaid limitation(s) or exclusion(s) may not apply to the purchaser.

EXCEPT AS PROVIDED ABOVE, IN NO EVENT WILL APC BE LIABLE FOR DIRECT, INDIRECT, SPECIAL, INCIDENTAL, OR CONSEQUENTIAL DAMAGES ARISING OUT OF THE USE OF THIS PRODUCT, EVEN IF ADVISED OF THE POSSIBILITY OF SUCH DAMAGE. Specifically, APC is not liable for any costs, such as lost profits or revenue, loss of equipment, loss of use of equipment, loss of software, loss of data, costs of substitutes, claims by third parties, or otherwise.

Entire contents copyright © 2003 by American Power Conversion Corporation. All rights reserved. Reproduction in whole or in part without permission is prohibited.

APC, Smart-UPS, and PowerChute are registered trademarks of American Power Conversion Corporation. All other trademarks are the property of their respective owners.